

# LEI

## 564.71 Ceiling

**Design:** Studio10

**Description:** In a world of spotlights with a masculine feel, Lei emerges: a system of technical spotlights with a crystalline and elegant aesthetic, based on curved elements that evoke the grace of the feminine universe, such as sartorial pleats and the sophisticated workmanship of precious perfume bottles. Available in matte black, brass, nickel and titanium finishes with clear and frosted glass or smoked, bottle green and red available on request. Lei is destined to capture every eye that passes, with its brilliant aesthetic presence.

**Materials:** metal, glass

**Mounting:** Ceiling hole: Ø 12cm. Light source: Gu10 bulb. Standard glass: Clear, Frost. Glass available on request: Smoke, Ruby Red, Bottle Green.

**Nt. Wt.:** 0,8 kg











**Class:** Degree of protection IP20, insulation class 1.

**Note:** 110/120V version available on request at additional price.  
Max dimensions bulb (not included):

CE  IP20



code	voltage	nominal flux	dimmability	finishes	cable (cm)	dimensions (cm)	recommended LED bulb
564.71	220/240V	/	according to bulb	C2 / C42 / C70	/	H 14 x Ø 16	1 x Gu10 max 4,5W

Hardware	Glass	
		C2 Matte Black + Clear Glass
		C2 Matte Black + Frost Glass
		C42 Satin Brass + Clear Glass
		C42 Satin Brass + Frost Glass
		C70 Titanium + Clear Glass
		C70 Titanium + Frost Glass

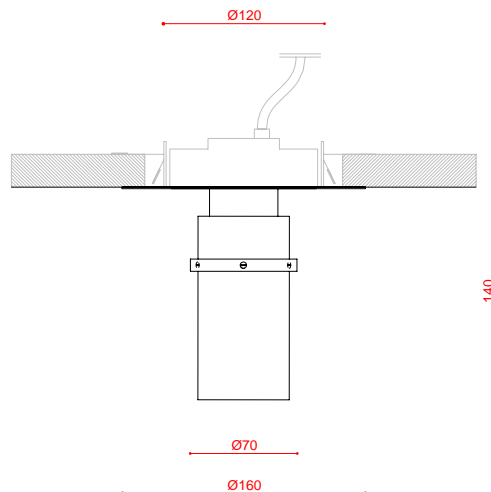

measurements in mm