

LEI

564.72 Ceiling

Design: Studio10

Description: In a world of spotlights with a masculine feel, Lei emerges: a system of technical spotlights with a crystalline and elegant aesthetic, based on curved elements that evoke the grace of the feminine universe, such as sartorial pleats and the sophisticated workmanship of precious perfume bottles. Available in matte black, brass, nickel and titanium finishes with clear and frosted glass or smoked, bottle green and red available on request. Lei is destined to capture every eye that passes, with its brilliant aesthetic presence.

Materials: metal, glass

Mounting: Ceiling hole: Ø 12cm. Light source: integrated LED, 12-40Vdc, CC 160mA. CRI>90. Dimmable LED. Lens: medium 24° beam. Standard glass: Clear, Frost. Glass available on request: Smoke, Ruby Red, Bottle Green.

Nt. Wt.: 0,8 kg











Class: Degree of protection IP20, insulation class 3.

Note: Remote driver included.
110/120V version available on request at additional price.
Lens: 18° beam and 36° beam available on request.



CE  IP20

code	voltage	nominal flux	dimmability	finishes	cable (cm)	dimensions (cm)	LED
564.72	12-40V CC 160mA	660 lm	phase cut	C2 / C42 / C70	/	H 14 x Ø 16	5W 2700K

Hardware	Glass	
		C2 Matte Black + Clear Glass
		C2 Matte Black + Frost Glass
		C42 Satin Brass + Clear Glass
		C42 Satin Brass + Frost Glass
		C70 Titanium + Clear Glass
		C70 Titanium + Frost Glass

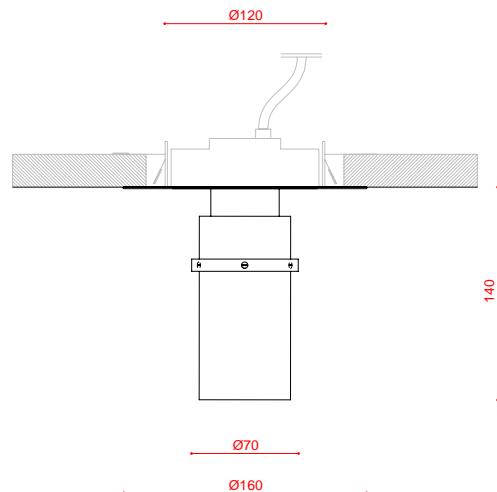

measurements in mm