

NASTRO

563.62L Floor

Picture on page 163/191 of the catalogue

Design: Studiopepe

Description: The Nastro floor lamps sees an epoxy powder coated aluminum band structure accompanied by a cylindric weight that counterbalances its flexuosity, in a refined visual balance. The light source consists of a dimmable LED strip; the cylinders are available in epoxy powder coated metal, in wood, in brushed brass and in raw concrete or marble effect.

Materials: aluminum, brass, wood, concrete, metal

Mounting: Floor: cable length 300 cm. Plug: type F (Schuko). Dimmer: 80 cm from the base on black fabric cable. Light source: Integrated LED.

Nt. Wt.: 9 kg (+ 2 kg for M01)







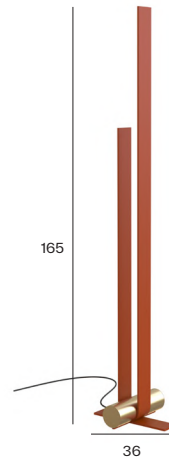





Class: Degree of protection IP40, insulation class 1.

Note: IP44 outdoor version available.
110/120V version available on request at additional price.

CE  IP40



code	voltage	nominal flux	dimmability	hardware finishes + cylinder	cable (cm)	dimensions (cm)	LED
563.62L	220/240V	6150 lm	dimmer on cable	all color combos (no M01)	300	H 165 x D 36	68W 2700K
563.62L	220/240V	6150 lm	dimmer on cable	all color combos + M01	300	H 165 x D 36	68W 2700K

Hardware	Cylinder	
		C22 Beige
		C23 Eggshell
		C25 Terracotta
		C26 Greenish-grey
		C74 Sand black
		C41 Brushed brass
		W01 Ash
		M01 Concrete

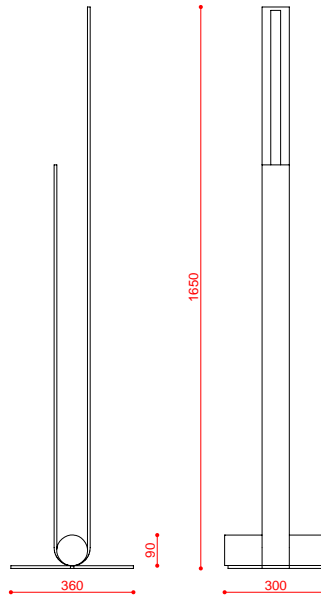

measurements in mm